

**Quality is the backbone
of the company**

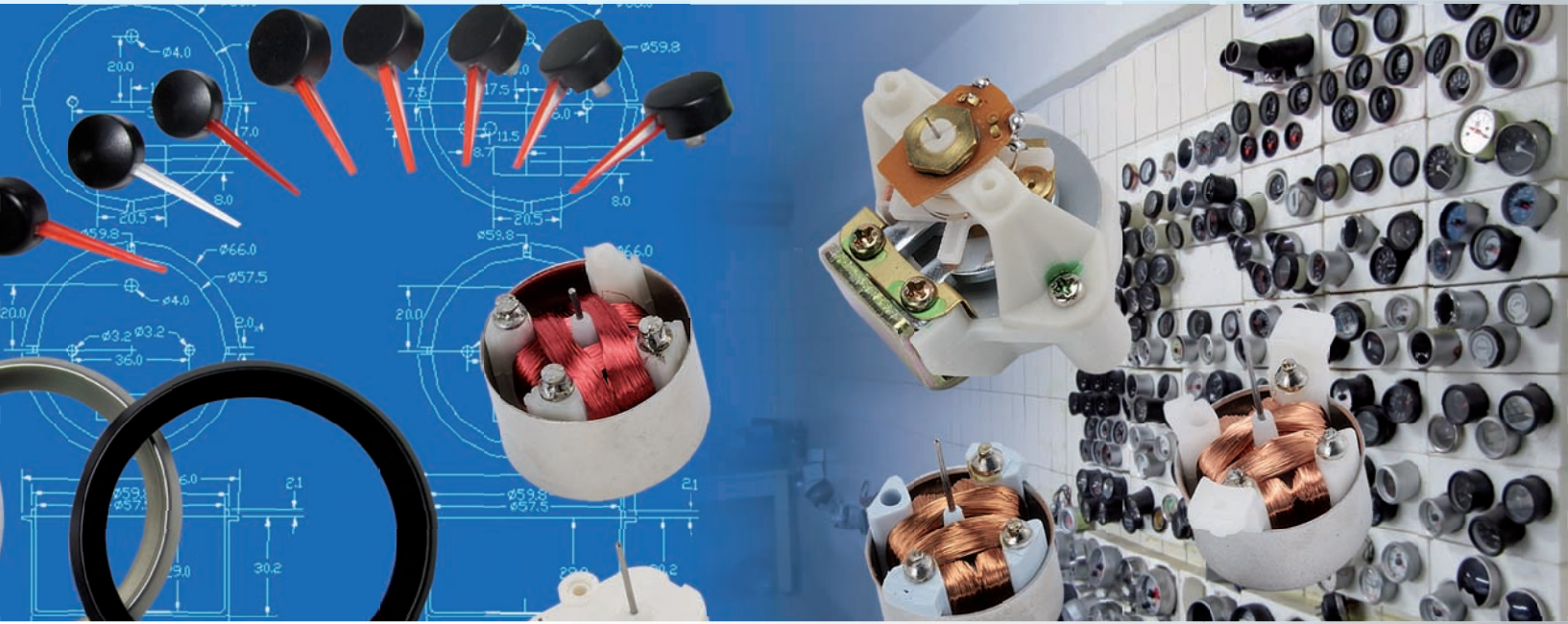

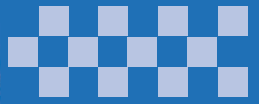

The RICO is an ISO 9001:2000 Certified OEM & ODM Company. Since 1984, RICO engaged on developing instrument movements, aftermarket performance meters, also as the sensors. Years of experiences help us build the solid foundation to coordinate the latest technology. Our successes as a leader of meter and sensors' design and development were built on quick response upon customers' requests and satisfying post-sale services. All of our products are carefully developed and planned by R&D, which create the flexibility on expanding the future product lines and ability to customize customers' requests.

Main Products

Automobile Meters
Marine Meters
Sensors
OEM Replacement
OEM , ODM WELCOME



History

RICO was started as OEM and specialized in PCB & movement of instruments assembly projects. The early mission of RICO focused on the principles of product quality. Because of this solid foundation and early experiences from these early projects, the emerged concepts of processes and tools were then applied into automotive aftermarket product lines.

The distinct quality accelerates our reputation. During the 1980s, RICO not only focused on its quality but also devoted our resources to innovate design and development in automotive aftermarket industry. The customized product lines and the customers are expanded worldwide in fast pace.

However, the core values of RICO are no difference from the beginning until today. The only difference is fast growing technology applications bring even more sophisticated product lines. Because of our over 25 years of professions and endeavors, we are confident the ability to offer the superior quality to our customers.

We believe customers' satisfaction is our first priorities. In other words, we believe long-term business relationship shall be built upon the reciprocal support between customers and all RICO's personnels. "Business is relationship" is our promise to all.

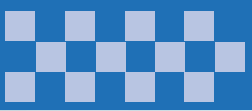

PAC45 Series

RICO supplies many more gauge types and gauge lines that may not be listed in here. For a complete listing for gauges available go to www.rico-instrument.com.

Actual product may vary from the item shown.

Units include mounting hardware & instructions

(*Do not find the products you need? Please contact us at service@rico-instrument.com.

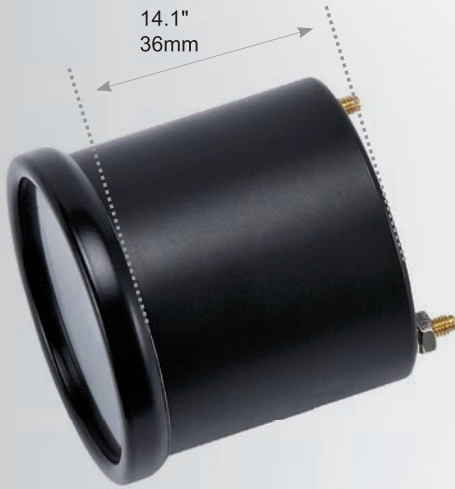

PAC45V

Description	Voltmeter
Range	8-18 V
Bezel*	Black
Dial*	Black
Needle*	Orange
Backlighting	White LED



PAC45WTC

Description	Water Temperature
Range	40-150 °C
Bezel*	Black
Dial*	Black
Needle*	Orange
Backlighting	White LED



PAC45WTF

Description	Water Temperature
Range	100-300 °F
Bezel*	Black
Dial*	Black
Needle*	Orange
Backlighting	White LED



PAC45OTC

Description	Oil Temperature
Range	40-150 °C
Bezel*	Black
Dial*	Black
Needle*	Orange
Backlighting	White LED



PAC45OTF

Description	Oil Temperature
Range	100-300 °F
Bezel*	Black
Dial*	Black
Needle*	Orange
Backlighting	White LED



PAC45OPBAR

Description	Oil Pressure
Range	0-7 BAR
Bezel*	Black
Dial*	Black
Needle*	Orange
Backlighting	White LED

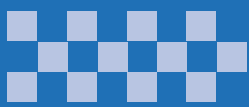

PAC45OPPSI

Description	Oil Pressure
Range	0-100 PSI
Bezel*	Black
Dial*	Black
Needle*	Orange
Backlighting	White LED



PAC45BSTBAR

Description	Boost
Range	-1-0-2 BAR
Bezel*	Black
Dial*	Black
Needle*	Orange
Backlighting	White LED



PAC45VAC

Description	Vacuum
Range	30-0 InHg
Bezel*	Black
Dial*	Black
Needle*	Orange
Backlighting	White LED



PAC45RPM

Description	Tachometer
Range	0-10000 RPM
Bezel*	Black
Dial*	Black
Needle*	Orange
Backlighting	White LED



PSTM52 Series

RICO supplies many more gauge types and gauge lines that may not be listed in here. For a complete listing for gauges available go to www.rico-instrument.com.

Actual product may vary from the item shown.

Units include mounting hardware & instructions

(*Do not find the products you need? Please contact us at service@rico-instrument.com



PSTM52V

Description	Voltmeter
Range	8-18 V
Bezel*	Black
Dial*	Black
Needle*	Orange
Backlighting	White LED



PSTM52WT

Description	Water Temperature
Range	20-120 °C
Bezel*	Black
Dial*	Black
Needle*	Orange
Backlighting	White LED



PSTM520T

Description	Oil Temperature
Range	50-150 °C
Bezel*	Black
Dial*	Black
Needle*	Orange
Backlighting	White LED



PSTM520P

Description	Oil Pressure
Range	0-10 BAR
Bezel*	Black
Dial*	Black
Needle*	Orange
Backlighting	White LED



PSTM52BST

Description	Boost
Range	-1-0- 2 BAR
Bezel*	Black
Dial*	Black
Needle*	Orange
Backlighting	White LED



PSTM52VAC

Description	Vacuum
Range	30-0 InHg
Bezel*	Black
Dial*	Black
Needle*	Orange
Backlighting	White LED



PSTM52RPM

Description	Tachometer
Range	0-10000 RPM
Bezel*	Black
Dial*	Black
Needle*	Orange
Backlighting	White LED



PSTM52EGT

Description	Exhaust Temperature
Range	200-1200 °C
Bezel*	Black
Dial*	Black
Needle*	Orange
Backlighting	White LED



PSTM52AF

Description	Air Fuel
Range	LEAN-STOICH-RICH
Bezel*	Black
Dial*	Black
Needle*	Orange
Backlighting	White LED

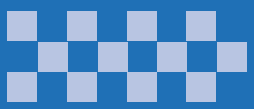

PSTM60 Series

RICO supplies many more gauge types and gauge lines that may not be listed in here. For a complete listing for gauges available go to www.rico-instrument.com.

Actual product may vary from the item shown.

Units include mounting hardware & instructions

(*)Do not find the products you need? Please contact us at atservice@rico-instrument.com



PSTM60VSET

Description	Voltmeter
Range	8-18 V
Bezel*	Black
Dial*	Black
Needle*	Orange
Backlighting	White LED



PSTM60WTSET

Description	Water Temperature
Range	20-120 °C
Bezel*	Black
Dial*	Black
Needle*	Orange
Backlighting	White LED



PSTM600T

Description	Oil Temperature
Range	50-150 °C
Bezel*	Black
Dial*	Black
Needle*	Orange
Backlighting	White LED



PSTM600P

Description	Oil Pressure
Range	0-10 BAR
Bezel*	Black
Dial*	Black
Needle*	Orange
Backlighting	White LED



PSTM60BST

Description	Boost
Range	-1-0- 2 BAR
Bezel*	Black
Dial*	Black
Needle*	Orange
Backlighting	White LED



PSTM60VAC

Description	Vacuum
Range	30-0 InHg
Bezel*	Black
Dial*	Black
Needle*	Orange
Backlighting	White LED



PSTM60RPM

Description	Tachometer
Range	0-10000 RPM
Bezel*	Black
Dial*	Black
Needle*	Orange
Backlighting	White LED



PSTM60EGT

Description	Exhaust Temperature
Range	200-1200°C
Bezel*	Black
Dial*	Black
Needle*	Orange
Backlighting	White LED



PSTM60AF

Description	Air Fuel
Range	LEAN-STOICH-RICH
Bezel*	Black
Dial*	Black
Needle*	Orange
Backlighting	White LED



DG Series

RICO supplies many more gauge types and gauge lines that may not be listed in here. For a complete listing for gauges available go to www.rico-instrument.com.

Actual product may vary from the item shown.

Units include mounting hardware & instructions

(*)Do not find the products you need? Please contact us at service@rico-instrument.com

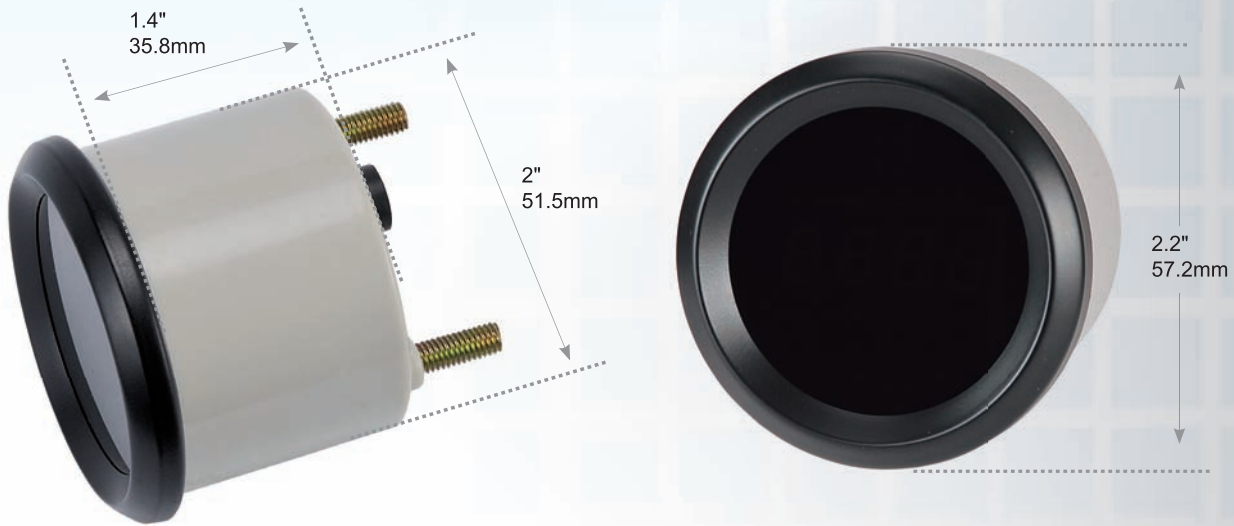

DG-52-V

Description	Voltmeter
Range	8-18 V
Bezel*	Black
Dial*	Black
Numeric LED	Red
Backlighting	Red LED



DG-52-WT

Description	Water Temperature
Range	40-150 °C / 100-300 °F
Bezel*	Black
Dial*	Black
Numeric LED	Red
Backlighting	Red LED

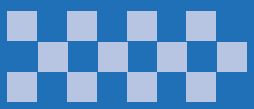

DG-52-OT

Description	Oil Temperature
Range	40-150°C / 100-300 °F
Bezel*	Black
Dial*	Black
Numeric LED	Red
Backlighting	Red LED



DG-52-OP

Description	Oil Pressure
Range	0-7 BAR / 0-100 PSI
Bezel*	Black
Dial*	Black
Numeric LED	Red
Backlighting	Red LED



DG-52-RPM

Description	Tachometer
Range	0-10000 RPM
Bezel*	Black
Dial*	Black
Numeric LED	Red
Backlighting	Red LED



DG-52-VB

Description	Voltmeter
Range	8-18 V
Bezel*	Black
Dial*	Black
Numeric LED	Blue
Backlighting	Red LED



DG-52-WTB

Description	Water Temperature
Range	40-150°C / 100-300 °F
Bezel*	Black
Dial*	Black
Numeric LED	Blue
Backlighting	Red LED



DG-52-OTB

Description	Oil Temperature
Range	40-150°C / 100-300 °F
Bezel*	Black
Dial*	Black
Numeric LED	Blue
Backlighting	Red LED



DG-52-OPB

Description	Oil Pressure
Range	0-7BAR / 0-100PSI
Bezel*	Black
Dial*	Black
Numeric LED	Blue
Backlighting	Red LED



DG-52-RPMB

Description	Tachometer
Range	0-10000RPM
Bezel*	Black
Dial*	Black
Numeric LED	Blue
Backlighting	Red LED

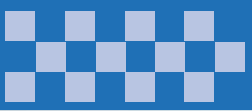

DGA Series

RICO supplies many more gauge types and gauge lines that may not be listed in here. For a complete listing for gauges available go to www.rico-instrument.com.

Actual product may vary from the item shown.

Units include mounting hardware & instructions

(*)Do not find the products you need? Please contact us at service@rico-instrument.com

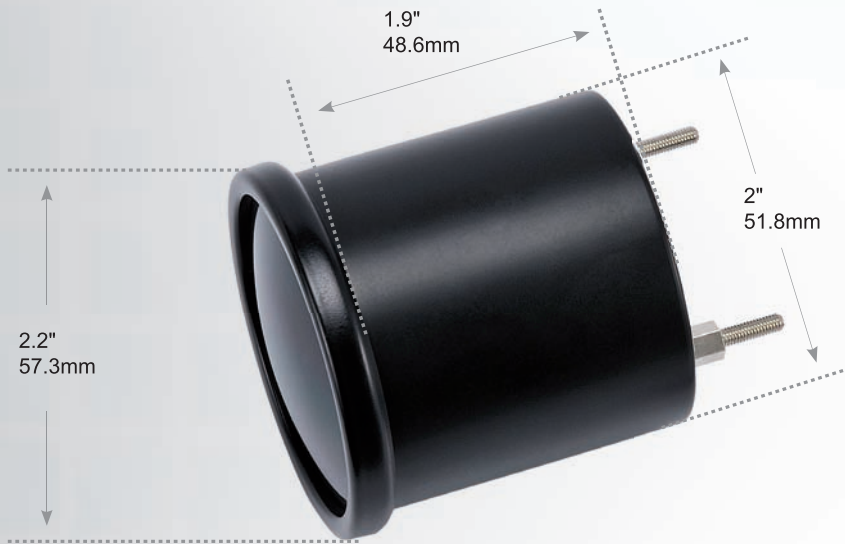

DGA-V

Description	Voltmeter
Range	8-18 V
Bezel*	Black
Dial*	Black
Numeric LED	Red
Backlighting	Red LED



DGA-WTC

Description	Water Temperature
Range	40-150 °C
Bezel*	Black
Dial*	Black
Numeric LED	Red
Backlighting	Red LED



DGA-OTC

Description	Oil Temperature
Range	40-150°C
Bezel*	Black
Dial*	Black
Numeric LED	Red
Backlighting	Red LED



DGA-OPBAR

Description	Oil Pressure
Range	0-7 BAR / 0-10 BAR
Bezel*	Black
Dial*	Black
Numeric LED	Red
Backlighting	Red LED



DGA-RPM

Description	Tachometer
Range	0-10000 RPM
Bezel*	Black
Dial*	Black
Numeric LED	Red
Backlighting	Red LED



DGA-TBPSI

Description	Turbo (Boost)
Range	0-30PSI
Bezel*	Black
Dial*	Black
Numeric LED	Red
Backlighting	Red LED

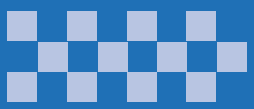

DGA-WL

Description	Water Level
Range	0-100%
Bezel*	Black
Dial*	Black
Numeric LED	Red
Backlighting	Red LED



DGA-FL

Description	Fuel Level
Range	0-100%
Bezel*	Black
Dial*	Black
Numeric LED	Red
Backlighting	Red LED



DGA-WTF

Description	Water Temperature
Range	100-300 °F
Bezel*	Black
Dial*	Black
Numeric LED	Red
Backlighting	Red LED



DGA-OTF

Description	Oil Temperature
Range	100-300 °F
Bezel*	Black
Dial*	Black
Numeric LED	Red
Backlighting	Red LED



DGA-OPPSI

Description	Oil Pressure
Range	0-100PSI / 0-145 PSI
Bezel*	Black
Dial*	Black
Numeric LED	Red
Backlighting	Red LED



DDG52APBAR

Description	Dual Display Air Pressure
Range	0-7 BAR / 0-10 BAR
Bezel*	Black
Dial*	Black
Numeric LED	Red
Backlighting	Red LED



DDG52APPSI

Description	Dual Display Air Pressure
Range	0-100PSI / 0-145 PSI
Bezel*	Black
Dial*	Black
Numeric LED	Red
Backlighting	Red LED



DDG52FL

Description	Dual Display Fuel Level
Range	0-100%
Bezel*	Black
Dial*	Black
Numeric LED	Red
Backlighting	Red LED

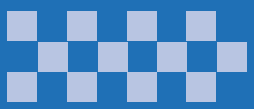

DDG52WL

Description	Dual Display Water Level
Range	0-100%
Bezel*	Black
Dial*	Black
Numeric LED	Red
Backlighting	Red LED

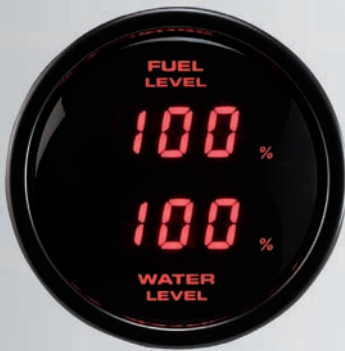

DDG52FLWL

Description	Dual Display Fuel Level & Water Level
Range	0-100%
Bezel*	Black
Dial*	Black
Numeric LED	Red
Backlighting	Red LED



DGAFL10A

Description	Bar-graph Fuel Level
Range	0-100%
Bezel*	Black
Dial*	Black
Bar-graph LED	Green & Red
Backlighting	Red LED

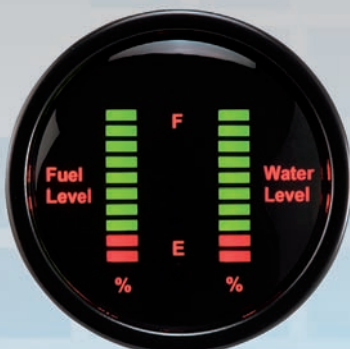

DDG52FLWL10A

Description	Dual Display Bar-graph Fuel Level & Water Level
Range	0-100%
Bezel*	Black
Dial*	Black
Bar-graph LED	Green & Red
Backlighting	Red LED



DDG52FL10A

Description	Dual Display Bar-graph Fuel Level
Range	E-F
Bezel*	Black
Dial*	Black
Bar-graph LED	Green & Red
Backlighting	Red LED



DDG52V10A

Description	Dual Display Bar-graph Voltmeter
Range	10-18 V
Bezel*	Black
Dial*	Black
Bar-graph LED	Green & Red & Yellow
Backlighting	Red LED



DDG52EGT12A

Description	Dual Display Bar-graph & Numeric combination Exhaust Temperature
Range	100-1200 °C
Bezel*	Black
Dial*	Black
Bar-graph LED	Green & Red & Yellow
Backlighting	Red LED

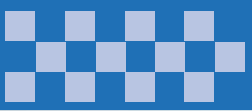

Shift Light Series

RICO supplies many more gauge types and gauge lines that may not be listed here. For a complete listing for gauges available go to www.rico-instrument.com.

Actual product may vary from the item shown.

Units include mounting hardware & instructions

(*Do not find the products you need? Please contact us service@rico-instrument.com



SLK-RPM-B

Description	Shift Light Tachometer
Adjustable	
Housing	Black
Lens	Available in Red and Blue



SLK-RPM-S

Description	Shift Light Tachometer
Adjustable	
Housing	Silver
Lens	Available in Red and Blue



SLD-RPM-B

Description	Shift Light Tachometer
Digital	
Housing	Black
Lens	0-180 Ω Or 240-30Ω
LED	Available in Red, Blue, and Green



SLD-RPM-S

Description	Shift Light Tachometer
Digital	
Housing	Silver
Lens	0-5V
LED	Available in Red, Blue, and Green



PAC85 Series

RICO supplies many more gauge types and gauge lines that may not be listed in here. For a complete listing for gauges available go to www.rico-instrument.com.

Actual product may vary from the item shown.

Units include mounting hardware & instructions

(*)Do not find the products you need? Please contact us at service@rico-instrument.com.



PAC85RPMSB

Description	Tachometer
Range	0-10000 RPM
Bezel*	Chrome
Dial*	Black
Needle*	Orange
Backlighting	White LED



PSTM85 Series

RICO supplies many more gauge types and gauge lines that may not be listed in here. For a complete listing for gauges available go to www.rico-instrument.com.

Actual product may vary from the item shown.

Units include mounting hardware & instructions

(*Do not find the products you need? Please contact us at atservice@rico-instrument.com



PSTM85SPSB

Description

Adjustable Speedometer/
Odometer (Records the total
distance of the vehicle has
been driven)/
Trip Odometer (Records the
distances between the two
individual trips)

Range

0-120MPH

Bezel*

Chrome

Dial*

Black

Needle*

Orange

Backlighting

White LED

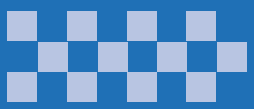

PAC125 Series

RICO supplies many more gauge types and gauge lines that may not be listed in here. For a complete listing for gauges available go to www.rico-instrument.com.

Actual product may vary from the item shown.

Units include mounting hardware & instructions

(*Do not find the products you need? Please contact us at service@rico-instrument.com

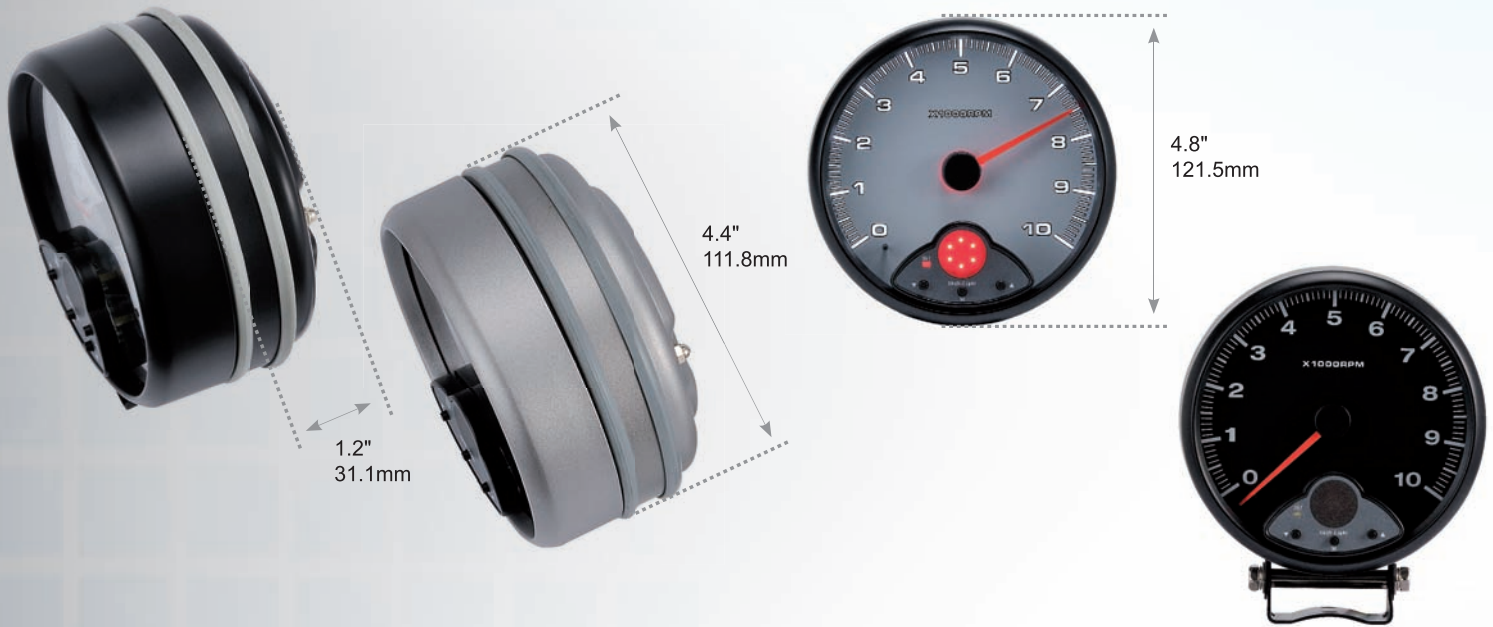

PAC125STBB

Description	Tachometer with shift light function
Range	0-10000RPM
Bezel*	Black
Dial*	Black
Needle*	Orange
Backlighting	White LED



PAC1253IN1BB

Description	Tachometer with shift light function & Exhaust temperature & Boost
Range	0-10000RPM 200-1200 °C 30InHg-0-30PSI
Bezel*	Black
Dial*	Black
Needle*	Orange
Backlighting	White LED
Numeric LED	Red



PAC1254IN1SB

Description	Tachometer with shift light function & Voltmeter & Water Temperature & Oil Pressure
Range	0-10000RPM 8-16 V 0-7 BAR 40-150 °C
Bezel*	Silver
Dial*	Black
Needle*	Orange
Backlighting	White LED

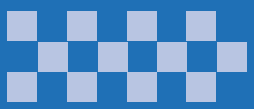

MWS Series

RICO supplies many more gauge types and gauge lines that may not be listed in here. For a complete listing for gauges available go to www.rico-instrument.com.

Actual product may vary from the item shown.

Units include mounting hardware & instructions

(*Do not find the products you need? Please contact us at service@rico-instrument.com.



MWS-52-V

Description	Voltmeter
Range	8-16 V
Bezel*	Black
Dial*	Black
Needle*	White & Black
Backlighting	White LED



MWS-52-WTC

Description	Water Temperature
Range	20-120 °C
Bezel*	Black
Dial*	Black
Needle*	White & Black
Backlighting	White LED



MWS-52-OPBAR

Description	Oil Pressure
Range	0-10 BAR
Bezel*	Black
Dial*	Black
Needle*	White & Black
Backlighting	White LED



MWS-52-WL

Description	Water Level
Range	0-1/2-4/4
Bezel*	Black
Dial*	Black
Needle*	White & Black
Backlighting	White LED



MWS-52-FL

Description	Fuel Level
Range	0-1/2-4/4
Bezel*	Black
Dial*	Black
Needle*	White & Black
Backlighting	White LED



MWS-52-RPM-8

Description	Gasoline Tachometer
Range	0-8000RPM
Bezel*	Black
Dial*	Black
Needle*	White & Black
Backlighting	White LED

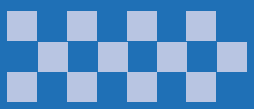

MWS-52-RPM-4

Description	Diesel Tachometer
Range	0-4000RPM
Bezel*	Black
Dial*	Black
Needle*	White & Black
Backlighting	White LED



MWS-52-AMP

Description	Ammeter
Range	-50-0-+50 AMP
Bezel*	Black
Dial*	Black
Needle*	White & Black
Backlighting	White LED



MXS Series

RICO supplies many more gauge types and gauge lines that may not be listed in here. For a complete listing for gauges available go to www.rico-instrument.com .

Actual product may vary from the item shown.

Units include mounting hardware & instructions

(*Do not find the products you need? Please contact us at service@rico-instrument.com

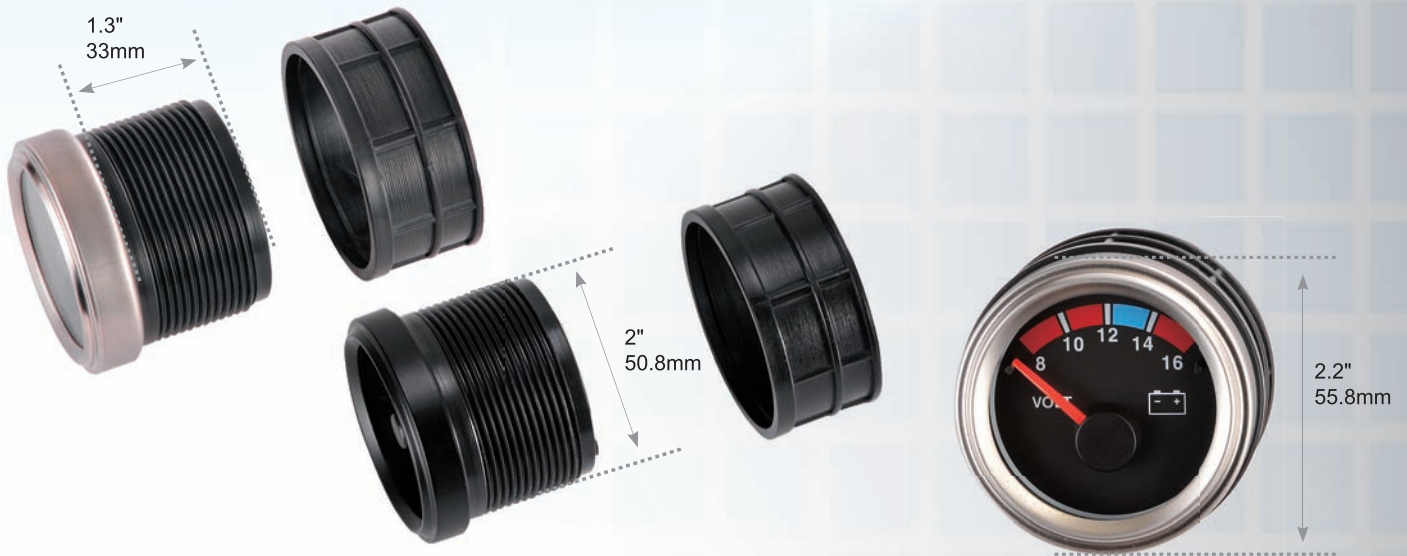

MXSV

Description	Voltmeter
Range	8-16 V
Bezel*	Chrome
Dial*	Black
Needle*	Orange
Backlighting	White LED



MXSWTC

Description	Water Temperature
Range	20-120 °C
Bezel*	Chrome
Dial*	Black
Needle*	Orange
Backlighting	White LED

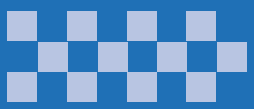

MXSOPBAR

Description	Oil Pressure
Range	0-10 BAR
Bezel*	Chrome
Dial*	Black
Needle*	Orange
Backlighting	White LED



MXSWL

Description	Water Level
Range	0-1/2-4/4
Bezel*	Chrome
Dial*	Black
Needle*	Orange
Backlighting	White LED



MXSFL

Description	Fuel Level
Range	0-1/2-4/4
Bezel*	Chrome
Dial*	Black
Needle*	Orange
Backlighting	White LED



MXSRPM4

Description	Diesel Tachometer
Range	0-4000 RPM
Bezel*	Chrome
Dial*	Black
Needle*	Orange
Backlighting	White LED



MXSRPM8

Description	Gasoline Tachometer
Range	0-8000 RPM
Bezel*	Chrome
Dial*	Black
Needle*	Orange
Backlighting	White LED



MXSAMP50

Description	Ammeter
Range	-50~0~+50 AMP
Bezel*	Chrome
Dial*	Black
Needle*	Orange
Backlighting	White LED

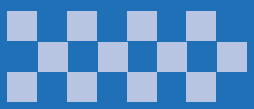

MXS25 Series

RICO supplies many more gauge types and gauge lines that may not be listed in here. For a complete listing for gauges available go to www.rico-instrument.com.

Actual product may vary from the item shown.

Units include mounting hardware & instructions

(*Do not find the products you need? Please contact us at service@rico-instrument.com.

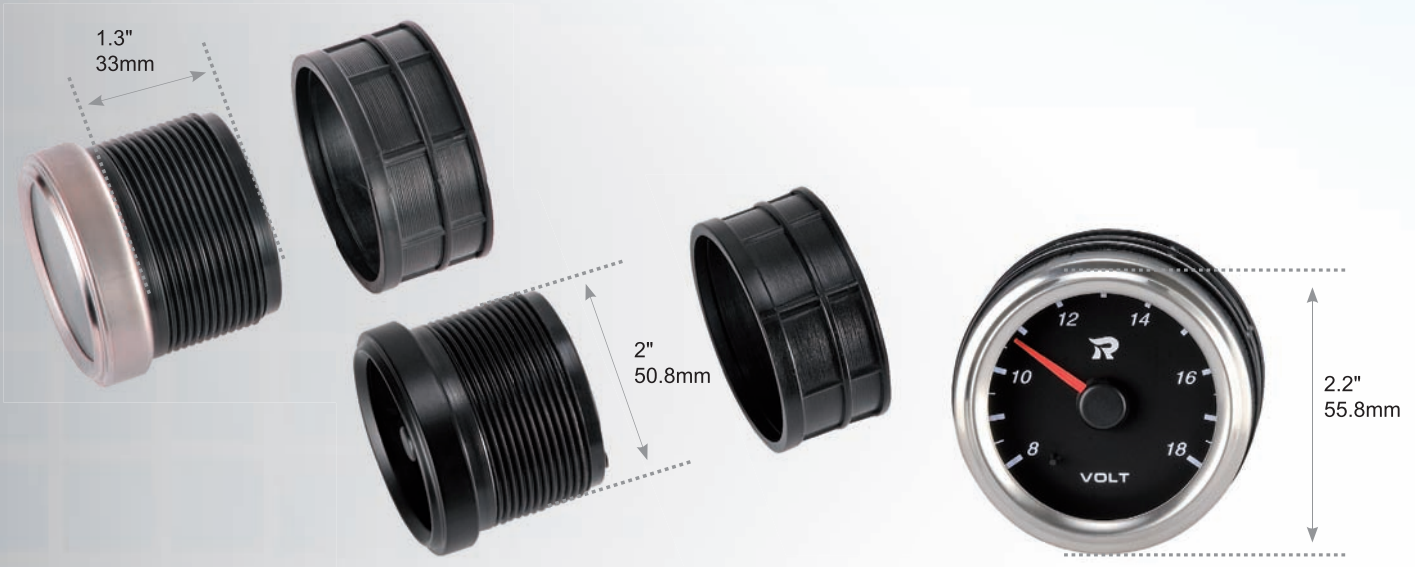

MXS25V

Description	Voltmeter
Range	8-18 V
Bezel*	Chrome
Dial*	Black
Needle*	Orange
Backlighting	White LED



MXS25WTC

Description	Water Temperature
Range	40-150 °C
Bezel*	Chrome
Dial*	Black
Needle*	Orange
Backlighting	White LED



MXS25OPBAR

Description	Oil Pressure
Range	0-7 BAR
Bezel*	Chrome
Dial*	Black
Needle*	Orange
Backlighting	White LED



MXS25WL

Description	Water Level
Range	E-1/2-F
Bezel*	Chrome
Dial*	Black
Needle*	Orange
Backlighting	White LED



MXS25FL

Description	Fuel Level
Range	E-1/2-F
Bezel*	Chrome
Dial*	Black
Needle*	Orange
Backlighting	White LED



MXS25RPM4

Description	Diesel Tachometer
Range	0-4000 RPM
Bezel*	Chrome
Dial*	Black
Needle*	Orange
Backlighting	White LED



MXS25RPM8

Description	Gasoline Tachometer
Range	0-8000 RPM
Bezel*	Chrome
Dial*	Black
Needle*	Orange
Backlighting	White LED



MXS25AMP50

Description	Ammeter
Range	-50~0~+50 AMP
Bezel*	Chrome
Dial*	Black
Needle*	Orange
Backlighting	White LED



MXS25BWTF

Description	Water Temperature
Range	100-300 °F
Bezel*	Black
Dial*	Black
Needle*	Orange
Backlighting	White LED



MXS25BOTC

Description	Oil Temperature
Range	40-150 °C
Bezel*	Black
Dial*	Black
Needle*	Orange
Backlighting	White LED



MXS25BOTF

Description	Oil Temperature
Range	100-300 °F
Bezel*	Black
Dial*	Black
Needle*	Orange
Backlighting	White LED



MXS25BVACINHG

Description	Vacuum
Range	30-0 In Hg
Bezel*	Black
Dial*	Black
Needle*	Orange
Backlighting	White LED



MXS25BBSTBAR

Description	Boost
Range	-1-0-2 BAR
Bezel*	Black
Dial*	Black
Needle*	Orange
Backlighting	White LED



MXS25BSTPSI

Description	Boost
Range	-30 InHg-0-30 PSI
Bezel*	Black
Dial*	Black
Needle*	Orange
Backlighting	White LED

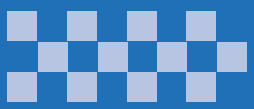

MXS25BRPM10

Description	Tachometer
Range	0-10000 RPM
Bezel*	Black
Dial*	Black
Needle*	Orange
Backlighting	White LED



MXS25BOPPSI

Description	Oil Pressure
Range	0-100 PSI
Bezel*	Black
Dial*	Black
Needle*	Orange
Backlighting	White LED



MXSDG Series

RICO supplies many more gauge types and gauge lines that may not be listed in here. For a complete listing for gauges available go to www.rico-instrument.com.

Actual product may vary from the item shown.

Units include mounting hardware & instructions

(*Do not find the products you need? Please contact us at service@rico-instrument.com



MXSDG-V

Description	Voltmeter
Range	8-18 V
Bezel*	Chrome
Dial*	Black
Numeric LED	Red
Backlighting	Red LED



MXSDG-WTC

Description	Water Temperature
Range	40-150 °C
Bezel*	Chrome
Dial*	Black
Numeric LED	Red
Backlighting	Red LED

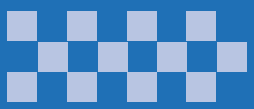

MXSDG-OTC

Description	Oil Temperature
Range	50-150 °C
Bezel*	Chrome
Dial*	Black
Numeric LED	Red
Backlighting	Red LED



MXSDG-OPBAR

Description	Oil Pressure
Range	0-7 BAR / 0-10 BAR
Bezel*	Chrome
Dial*	Black
Numeric LED	Red
Backlighting	Red LED



MXSDG-WTF

Description	Water Temperature
Range	100-300 °F
Bezel*	Chrome
Dial*	Black
Numeric LED	Red
Backlighting	Red LED



MXSDG-OTF

Description	Oil Temperature
Range	50-150 °C
Bezel*	Chrome
Dial*	Black
Numeric LED	Red
Backlighting	Red LED



MXSDG-OPPSI

Description	Oil Pressure
Range	0-100PSI /0-145PSI
Bezel*	Chrome
Dial*	Black
Numeric LED	Red
Backlighting	Red LED



MXSDG-FL

Description	Fuel Level
Range	0-100%
Bezel*	Chrome
Dial*	Black
Numeric LED	Red
Backlighting	Red LED



MXSDG-WL

Description	Water Level
Range	0-100%
Bezel*	Chrome
Dial*	Black
Numeric LED	Red
Backlighting	Red LED



MXSDG-RPM

Description	Tachometer
Range	0-10000RPM
Bezel*	Chrome
Dial*	Black
Numeric LED	Red
Backlighting	Red LED

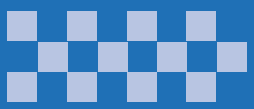

MXSDDGFL

Description	Dual Display Fuel Level
Range	0-100%
Bezel*	Chrome
Dial*	Black
Numeric LED	Red
Backlighting	Red LED



MXSDDGWL

Description	Dual Display Water Level
Range	0-100%
Bezel*	Chrome
Dial*	Black
Numeric LED	Red
Backlighting	Red LED



MXSDDGFLWL

Description	Dual Display Fuel Level & Water Level
Range	0-100%
Bezel*	Chrome
Dial*	Black
Numeric LED	Red
Backlighting	Red LED



MXSDDGAPBAR

Description	Dual Display Air Pressure
Range	0-7 BAR / 0-10 BAR
Bezel*	Chrome
Dial*	Black
Numeric LED	Red
Backlighting	Red LED



MXSDDGAPPSI

Description	Dual Display Air Pressure
Range	0-100 PSI / 0-145 PSI
Bezel*	Chrome
Dial*	Black
Numeric LED	Red
Backlighting	Red LED

DGS Hourmeter

RICO supplies many more gauge types and gauge lines that may not be listed in here. For a complete listing for gauges available go to www.rico-instrument.com.

Actual product may vary from the item shown.

Units include mounting hardware & instructions

(*Do not find the products you need? Please contact us at service@rico-instrument.com



DGS-HM

Description	Dual function Inductive Hour Meter
Color	Black
Display Range	999.99 hours
Dimension	45mm (L) x 30mm (W) x 15mm (H)

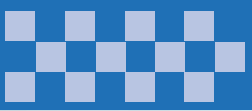

GV Series

RICO supplies many more gauge types and gauge lines that may not be listed in here. For a complete listing for gauges available go to www.rico-instrument.com.

Actual product may vary from the item shown.

Units include mounting hardware & instructions

(*)Do not find the products you need? Please contact us at service@rico-instrument.com.

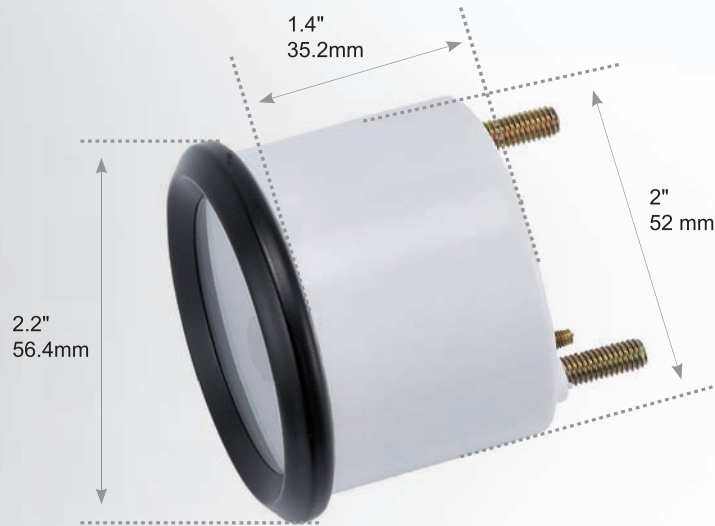

GV-V

Description	Voltmeter
Display Range	8-16V
Bezel*	Black
Dial*	Black
Housing	White
Backlighting*	Light bulb



GV-V-24

Description	Voltmeter
Display Range	16-32V
Bezel*	Black
Dial*	Black
Housing	White
Backlighting*	Light bulb



GV-WT

Description	Water Temperature
Display Range	40-120°C
Bezel*	Black
Dial*	Black
Housing	White
Backlighting*	Light bulb



GV-OP

Description	Oil Pressure
Display Range	0-7 BAR
Bezel*	Black
Dial*	Black
Housing	White
Backlighting*	Light bulb



GV-FL

Description	Fuel Level
Display Range	E-1/2-F
Bezel*	Black
Dial*	Black
Housing	White
Backlighting*	Light bulb



GV-CLK

Description	Digital Clock
Display Range	24 hours mode
Bezel*	Black
Dial*	Black
Housing	White
Backlighting*	Light bulb

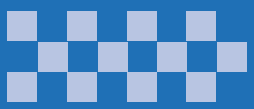

GV-BL

Description	Battery Level
Bezel*	Black
Dial*	Black
Housing	White
Backlighting*	Bar-graph LED (green, yellow, red)

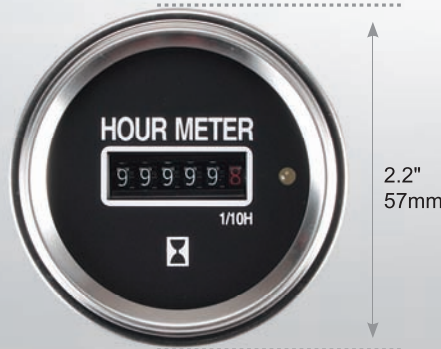
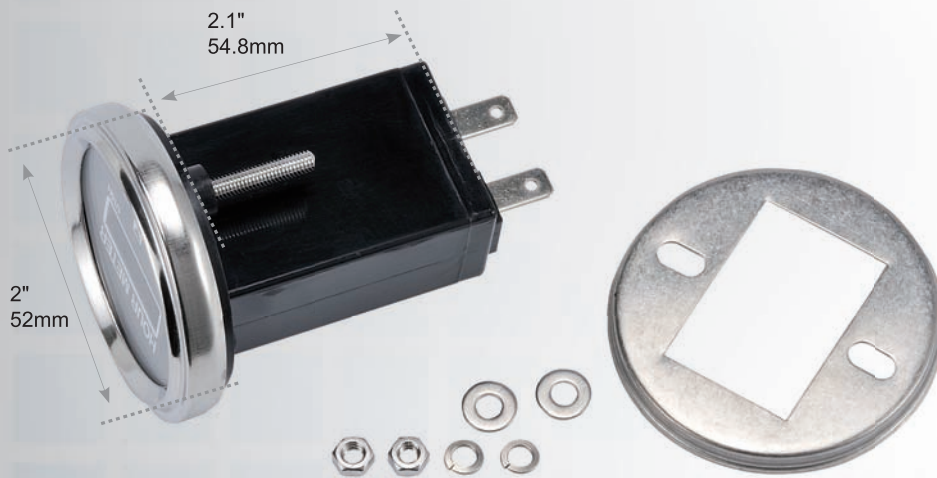

GV-HM

Description	Hourmeter
Display Range	0-99999.9
Bezel*	Chrome or Black
Dial*	Black
Housing	Black
Backlighting*	



Temperature Sensor

RICO supplies many more gauge types and gauge lines that may not be listed in here. For a complete listing for gauges available go to www.rico-instrument.com .

Actual product may vary from the item shown.

Units include mounting hardware & instructions

(*)Do not find the products you need? Please contact us at service@rico-instrument.com



WTS

Description	Temperature Sensor
Input temperature	40 to 150°C
Output resistance	925 to 38 Ω



MWTS

Description	Temperature Sensor
Input temperature	40 to 150°C
Output resistance	280 to 9.8 Ω

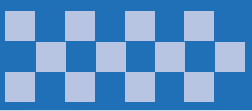

Pressure Sensor

RICO supplies many more gauge types and gauge lines that may not be listed in here. For a complete listing for gauges available go to www.rico-instrument.com.

Actual product may vary from the item shown.

Units include mounting hardware & instructions

(*)Do not find the products you need? Please contact us at service@rico-instrument.com.



OPS-1 POLE

Description	Oil Pressure Sensor
Input pressure	0 to 10 BAR
Output	resistance or voltage
	0 to 160Ω Or 240 to 27Ω
Input voltage*	



OPS-2 POLE

Description	Oil Pressure Sensor
Input pressure	0 to 10 BAR
Output	resistance or voltage
	3 to 160 Ω
Input voltage*	



OPS-C

Description	
Input pressure	0-10BAR
Output	resistance or voltage
	0.5-4.5V
Input voltage*	12 V



OPS-D



Description

Input pressure 0-7BAR

Output

resistance or voltage 0.5-4.5V

Input voltage* 12 V

Boost Sensor

RICO supplies many more gauge types and gauge lines that may not be listed in here. For a complete listing for gauges available go to www.rico-instrument.com .

Actual product may vary from the item shown.

Units include mounting hardware & instructions

(*)Do not find the products you need? Please contact us at service@rico-instrument.com .

BTS-E



Description

Boost Sensor E type

Input pressure -1 to 3 BAR

Output voltage 0.5-4.5V

Input voltage* 12V

BTS-S



Description

Boost Sensor S type

Input pressure -1 to 3 BAR

Output voltage 0.5-4.5V

Input voltage* 12V

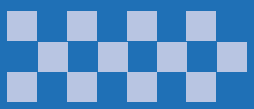

Liquid Level Sensor

RICO supplies many more gauge types and gauge lines that may not be listed in here. For a complete listing for gauges available go to www.rico-instrument.com .

Actual product may vary from the item shown.

Units include mounting hardware & instructions

(*)Do not find the products you need? Please contact us at service@rico-instrument.com .



LR

Description	Liquid Level Sensor
Input	E-1/4-3/4-F
Output resistance or voltage	240-30Ω
Input voltage*	

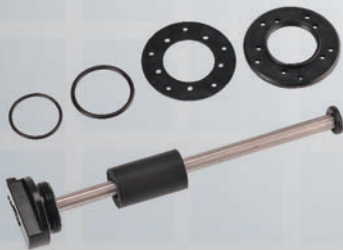

LSR

Description Reed Switch	Liquid Level Sensor
Input	E-1/4-3/4-F
Output resistance or voltage	0-180 Ω Or 240-30Ω
Input voltage*	



LLS

Description Linear	Liquid Level Sensor Warning function is available
Input	E-1/4-3/4-F
Output resistance or voltage	0-5V
Input voltage*	12V



Exhaust Temperature Sensor

RICO supplies many more gauge types and gauge lines that may not be listed in here. For a complete listing for gauges available go to www.rico-instrument.com .

Actual product may vary from the item shown.

Units include mounting hardware & instructions

(*)Do not find the products you need? Please contact us at service@rico-instrument.com



EGTS-L

Description	Exhaust Temperature Sensor L type
Input Temperature	0-1300°C
Output voltage	0-52.398mV
Input voltage*	12V



EGTS-S

Description	Exhaust Temperature Sensor Straight type
Input Temperature	0-1300°C
Output voltage	0-52.398mV
Input voltage*	12V

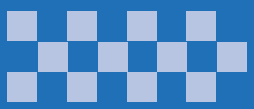

Meter Panel

RICO supplies many more gauge types and gauge lines that may not be listed in here. For a complete listing for gauges available go to www.rico-instrument.com.

Actual product may vary from the item shown.

Units include mounting hardware & instructions

(*)Do not find the products you need? Please contact us at service@rico-instrument.com.



MP-1HOLE-B

Description	Meter Panel
Color	Black
Size	52mm or 60mm



MP-2HOLE-B

Description	Meter Panel
Color	Black
Size	52mm or 60mm



MP-3HOLE-B

Description	Meter Panel
Color	Black
Size	52mm or 60mm



MP-1HOLE-C

Description	Meter Panel
Color	Chrome
Size	52mm or 60mm



MP-2HOLE-C

Description	Meter Panel
Color	Chrome
Size	52mm or 60mm



MP-3HOLE-C

Description	Meter Panel
Color	Chrome
Size	52mm or 60mm

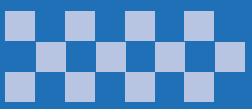

Meter Stand

RICO supplies many more gauge types and gauge lines that may not be listed in here. For a complete listing for gauges available go to www.rico-instrument.com.

Actual product may vary from the item shown.

Units include mounting hardware & instructions

(*)Do not find the products you need? Please contact us at service@rico-instrument.com.



MSTD-M-52

Description	Meter Stand
Color	Black
Size	52mm



MSTD-M-60

Description	Meter Stand
Color	Black
Size	60mm



MSTD-P-52

Description	Meter Stand
Color	Silver or Black
Size	



NOTEPAD



No.2, Alley 27, Lane 143, Yuan Shan Road,
Chung Ho District, New Taipei City 23552, Taiwan
Phone: +886-2-2223-7866
Fax: +886-2-2223-7869
Email: service@rico-instrument.com
Website: www.RICO-instrument.com

© RICO INSTRUMENT CO., LTD.
All rights reserved.
Printed in Taiwan